





■ Features :

- Universal AC input / Full range
- Fully isolated plastic case with IP64 level
- Built-in constant current limiting circuit with adjustable OCP level
- Protections: Short circuit / Overload / Over voltage
- Optional dimming function : 1.1~10VDC (D type) or PWM (P type) controlled
- UL1310 Class 2 power unit
- Pass LPS
- Cooling by free air convection
- 100% full load burn-in test
- Suitable for LED lighting and moving sign applications (Note.8)
- Low cost
- 2 years warranty

SPECIFICATION

LPS IP64  (for 48V only)  US (except for 48V) 

MODEL	ELN-30-5	ELN-30-9	ELN-30-12	ELN-30-15	ELN-30-24	ELN-30-27	ELN-30-48	
OUTPUT	DC VOLTAGE	5V	9V	12V	15V	24V	27V	48V
	LED OPERATION VOLTAGE Note.7	3 ~ 5V	3 ~ 9V	3 ~ 12V	3 ~ 15V	3 ~ 24V	3 ~ 27V	3 ~ 48V
	RATED CURRENT	5A	3.4A	2.5A	2A	1.25A	1.12A	0.63A
	CURRENT RANGE	0 ~ 5A	0 ~ 3.4A	0 ~ 2.5A	0 ~ 2A	0 ~ 1.25A	0 ~ 1.12A	0 ~ 0.63A
	RATED POWER	25W	30.6W	30W	30W	30W	30.24W	30.24W
	RIPPLE & NOISE (max.) Note.2	80mVp-p	100mVp-p	120mVp-p	120mVp-p	150mVp-p	150mVp-p	250mVp-p
	VOLTAGE ADJ. RANGE	4.5 ~ 5.5V	8.7 ~ 10.5V	10.8 ~ 13.2V	13.5 ~ 16.5V	21.6 ~ 26.4V	24.3 ~ 29.7V	43.2 ~ 52.8V
		Can be adjusted by internal potential meter SVR1						
	CURRENT ADJ. RANGE	-25% ~ 3%. Can be adjusted by internal potential meter SVR2						
	VOLTAGE TOLERANCE Note.3	±5.0%						
LINE REGULATION	±1.0%							
LOAD REGULATION	±2.0%							
SETUP, RISE TIME Note.6	500ms, 80ms / 230VAC 1000ms, 80ms / 115VAC at full load							
HOLD UP TIME (Typ.)	50ms/230VAC 16ms/115VAC at full load							
INPUT	VOLTAGE RANGE Note.4	90 ~ 264VAC		127 ~ 370VDC				
	FREQUENCY RANGE	47 ~ 63Hz						
	EFFICIENCY (Typ.)	75%	80%	82%	82%	85%	85%	87%
	AC CURRENT	0.75A/115VAC		0.48A/230VAC				
	INRUSH CURRENT(max.)	COLD START 60A/230VAC						
LEAKAGE CURRENT	0.25mA / 240VAC							
PROTECTION	OVER CURRENT	95 ~ 110%						
		Protection type : Constant current limiting, recovers automatically after fault condition is removed						
OVER VOLTAGE		5.75 ~ 6.75V	11 ~ 13.5V	13.8 ~ 16V	17.5 ~ 21V	28 ~ 32V	31 ~ 36.4V	54 ~ 60V
		Protection type : Shut down o/p voltage, re-power on to recover						
FUNCTION	DIMMING CONTROL (OPTIONAL)	1.1 ~ 10VDC or PWM						
ENVIRONMENT	WORKING TEMP.	-20 ~ +60°C (Refer to output load derating curve)						
	WORKING HUMIDITY	20 ~ 90% RH non-condensing						
	STORAGE TEMP., HUMIDITY	-40 ~ +80°C, 10 ~ 95% RH						
	TEMP. COEFFICIENT	±0.03%/°C (0 ~ 50°C)						
	VIBRATION	10 ~ 500Hz, 2G 10min./1cycle, period for 60min. each along X, Y, Z axes						
SAFETY & EMC	SAFETY STANDARDS	UL1310 Class 2, CAN/CSA C22.2 No. 223-M91(except for 48V), IP64 approved ; design refer to TUV EN60950-1, EN61347-2-13						
	WITHSTAND VOLTAGE	I/P-O/P:3KVAC						
	ISOLATION RESISTANCE	I/P-O/P:>100M Ohms / 500VDC / 25°C / 70% RH						
	EMI CONDUCTION & RADIATION	Compliance to EN55022 (CISPR22) Class B						
	HARMONIC CURRENT	Compliance to EN61000-3-2 Class A, EN61000-3-3						
	EMS IMMUNITY	Compliance to EN61000-4-2,3,4,5,6,8,11; ENV50204, EN55024, light industry level, criteria A						
OTHERS	MTBF	628.3Khrs min. MIL-HDBK-217F (25°C)						
	DIMENSION	145*47*30mm (L*W*H)						
	PACKING	0.26Kg; 60pcs/16.6Kg/1.25CUFT						
NOTE	<ol style="list-style-type: none"> 1. All parameters NOT specially mentioned are measured at 230VAC input, rated load and 25°C of ambient temperature. 2. Ripple & noise are measured at 20MHz of bandwidth by using a 12" twisted pair-wire terminated with a 0.1uf & 47uf parallel capacitor. 3. Tolerance : includes set up tolerance, line regulation and load regulation. 4. Derating may be needed under low input voltage. Please check the static characteristics for more details. 5. The power supply is considered as a component that will be operated in combination with final equipment. Since EMC performance will be affected by the complete installation, the final equipment manufacturers must re-qualify EMC Directive on the complete installation again. 6. Length of set up time is measured at first cold start. Turning ON/OFF the power supply may lead to increase of the set up time. 7. Constant current operation region is within the specified output voltage range above. This is the suitable operation region for LED related applications. 8. In the European market this power supply can be used for LED lighting applications with input power up to 25W. 							

Mechanical Specification

Case No.964A Unit:mm

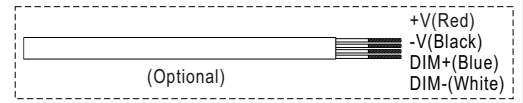
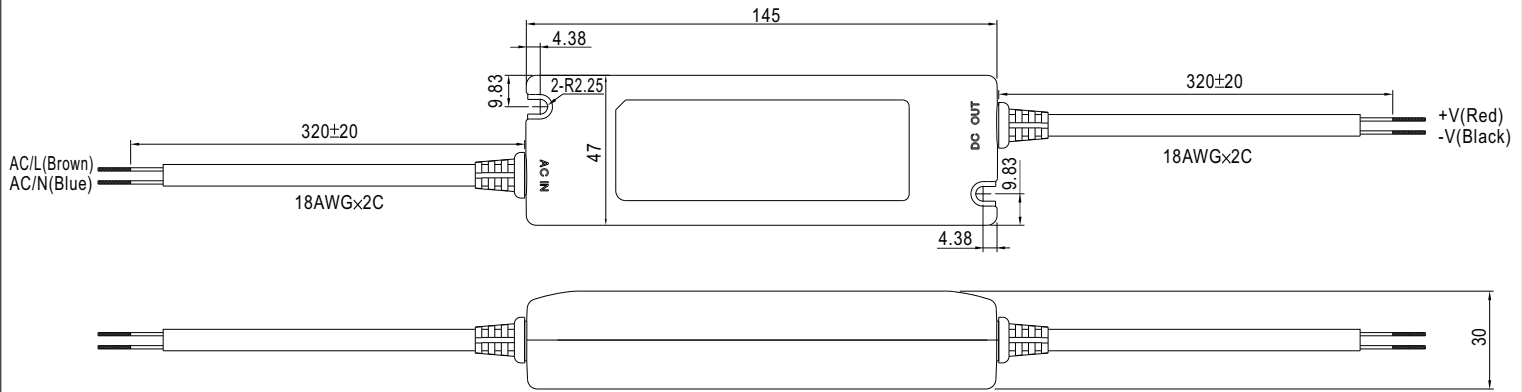

Output voltage and current adjustment : remove the upper case and adjust through SVR1 & SVR2 shown in the diagram.

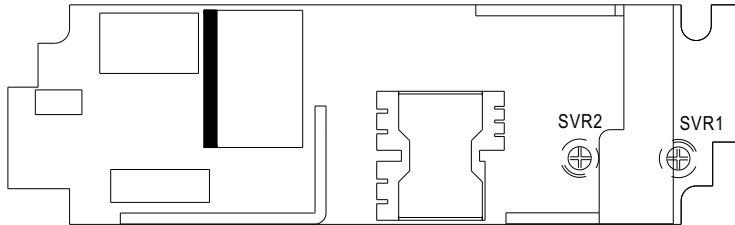

Block Diagram

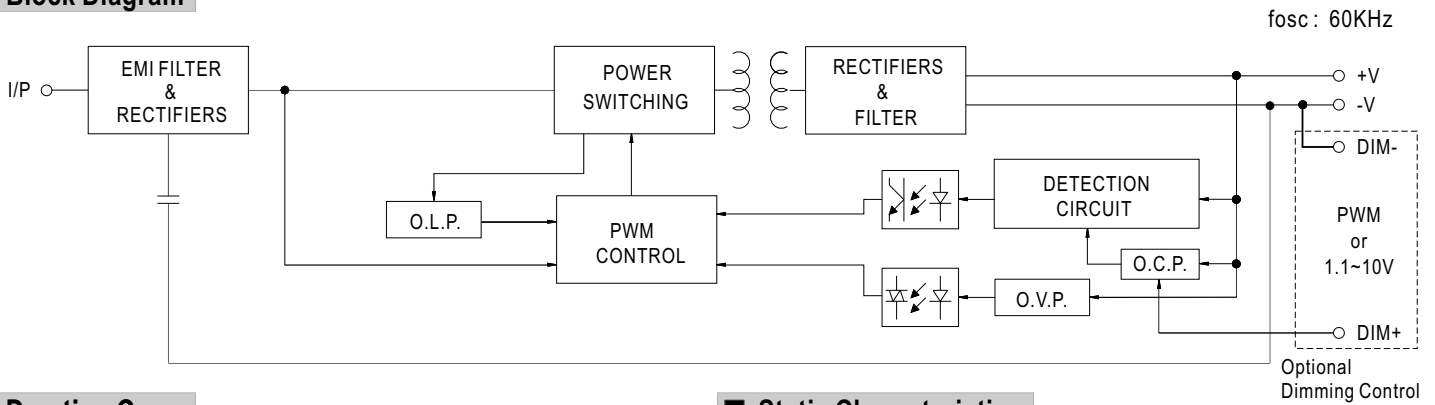

Derating Curve

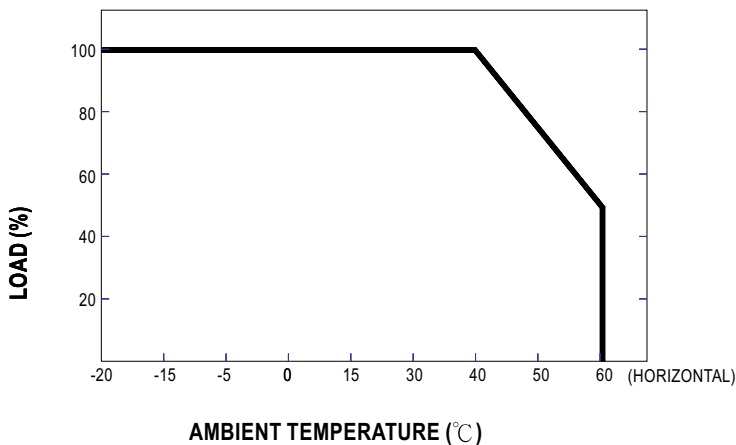

Static Characteristics

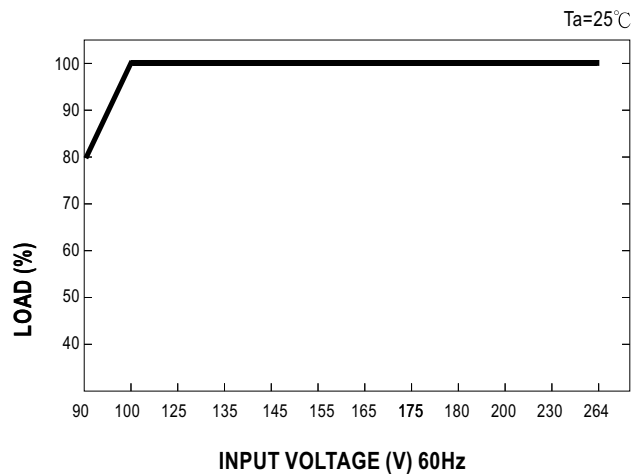

■ Dimming Control (Optional)

Level of output current can be adjusted through the dimming control function.

When there is no signal sending to the control wires (open circuit between the two control wires), the power supply unit will operate as 0V (D-type) or 0% duty (P-type) of input signal and hence the output current will be zero.

(1) 1.1~10V (D type, & : ELN-30-12D)

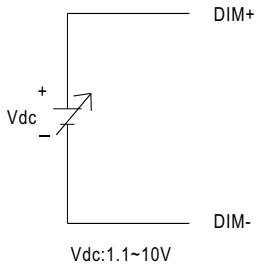

(2) PWM (P type, & : ELN-30-12P)

